

Modeling Of Dynamic Processes In Heterogeneous Environments To Support The Adoption Of Technological Decisions

Juraev Tokhirjon

*Namangan Engineering Construction Institute Namangan, Republic of Uzbekistan
tohir2001@mail.ru*

Abstract: *The article analyzes the management of the technological process of underground mixing in a non-homogeneous environment and the development of a computer model of the process of underground mixing in a layered system environment to support decision making. A mathematical model of the management of the underground mixing process in the conditions of a layered system of development has been developed; the dynamics of the reagent concentration and pressure value at different values of the parameters affecting the technological process of underground mixing in the conditions of the layered system of development were studied; a computer model was developed to conduct numerical experiments and visualize the results in two- and three-dimensional graphics; a software package of the underground mixing process was developed to support technological decision-making in the management of the development of mineral deposits in the conditions of a stratified system of development. The developed computational algorithms and computer model can be used in decision-making, analysis and forecasting of parameters of the underground mixing process in order to optimally obtain minerals from real deposits developed in the stratified system of underground mixing.*

Keywords: *Underground mixing, layered system of development, specific gravity of reagent, hydrodynamics, concentration, computer model, numerical-approximate method, flow drive, variable directional method, control parameters, decision support, control scheme.*

1. INTRODUCTION

The development of mineral deposits by the method of underground leaching (pv) is widely used in the uranium mining industry, which is of extremely important economic importance. Choosing the optimal development system is the most crucial step in designing future ore mining. All economic performance indicators of the mine depend on the development system (system costs reach 60% of all general labor costs), the safety of miners, the use of certain mining equipment.

Each system can be used only in certain mining and geological conditions. The most significant influence on the choice of a development system is the power of the ore body, angle of incidence, stability of ore and host rocks. Consideration of these factors allows us to

clarify and concretize the choice of a development system, add some details, elements to the production technology.

The main feature of the floor PV system is the mining of ore deposits through floor-mounted filters of technological wells (pump filters under the pool, pump filters above it, or vice versa). The system distinguishes three options for borehole mining - floor with single-row arrangement of wells (production cells), floor and two-story with staggered or rectangular arrangement of wells for mining wide and two-winged ore deposits.

The complexity of the process in the conditions of a floor development system necessitates the development of mathematical models and software for studying the entire cycle of the process of PV in real conditions and making decisions in accordance with the purpose of management. The main goal of creating the model is to characterize and predict some objects and technological processes. Models based on a mathematical interpretation of the problem help in finding the necessary information to support the adoption of technological decisions. Thus, the development of models for solving the problems of analysis and decision-making in the management of technological processes of mineral water during mining in the conditions of a floor development system, as well as the creation of appropriate computational algorithms and software, are an urgent task.

2. LITERATURE REVIEW

The main process of mineral extraction by the PV method in the conditions of a floor development system is accompanied by the processes of movement of the leaching solution in heterogeneous media from top to bottom, i.e. from an injection well to a production well through ore-bearing zones; diffusion processes in the ore-bearing zone ensure the transition of matter from one phase to another.

Foreign researchers V.Zh. made a significant contribution to solving these issues. Arens, V.G. Bakhurov, N.P. Buslenko, N.N. Verigin, L.G. Voroshnin, V.S. Golubev, V.A. Grabovnikov, A.N. Konovalov, L. Luckner, V.M. Shestakov, I.K. Lutsenko, V.I. Beletsky, V.A. Mamilov, V.N. Nikolaevsky, G.Kh Khcheyan, I.S. Naftulin, I.A. Charny, E.I. Rogov, V.G. Languages, M.V. Shumilin, as well as domestic scientists V.K. Kabulov, V.R. Rakhimov, F.B. Abutaliev, N.M. Mukhidinov, I. Alimov, R. Sadullaev, N. Ravshanov, A.M. Siddikov, G.N. Glotov and others. They examined the physical and mathematical foundations of geotechnological processes of mining, compiled the basic equations and methods for the engineering calculation of heat, filtration and other tasks of underground smelting, dissolution and leaching processes, and formulated control tasks using various geotechnological development methods.

For these areas, numerous mathematical models and computational algorithms have been developed when the object is considered mainly in plan.

Under such development conditions, it is necessary to consider the models not in terms of, but in the context. In addition, in the mathematical model of the leaching process, it is necessary to additionally take into account the factor of gravity, the role of which largely depends on the specific gravity of the injected solution and the pressure differences at different depths of the field.

An analysis of the models developed to date has shown that they pay little attention to the floor development system, which has been successfully applied in practice. In this regard, this

dissertation focuses on the problems of developing computer models for the control of the PV process occurring in the conditions of a floor development system, as well as the tasks associated with it, such as presenting the results in numerical, two-dimensional and three-dimensional graphical form to support the adoption of technological decisions and forecasting.

3. METHODS AND ANALYSIS

The heterogeneity of the filtration coefficient of ores and host rocks adversely affects the leaching process. The technological mode of operation of the wells determines the conditions for its operation. Throughout the entire period of operation of the wells, it is necessary to obtain the maximum possible amount of minerals at the minimum cost of working agents.

For maximum mining, it is required to ensure uniform leaching of the developed formation without unnecessary reagent costs. Based on the PV technology, it can be assumed that the controlling factors are the flow rates of injection and production wells, as well as the proportion of acid in the leaching reagent.

These goals are achieved by solving the following tasks:

1) minimize the objective function R:

$$R(Q) = \int_0^T \sum_{i=1}^{M_i} [C_i(U_i, Q, t) - C_{ib}(U_i, Q, t)]^2 dt, \quad (1)$$

$$R^* = \min_{(x,z) \in G} R(Q),$$

selection of flow rates of injection and production wells under the criterion

$$Q = \sum_{i=1}^{M_i} q_i, \quad q_{\min} \leq |q_i| \leq q_{\max}.$$

2) minimize objective function R:

$$R(\gamma) = \int_0^T \sum_{i=1}^{M_i} [C_i(U_i, \gamma, t) - C_{ib}(U_i, \gamma, t)]^2 dt, \quad (2)$$

$$R^* = \min_{\gamma \in \Omega} R(\gamma),$$

selection of reagent concentration γ until the desired (predetermined) value of the concentration of the target product in production wells is achieved with $0 < \gamma < 10$.

Here $C_{ib}(U_i, Q, t)$ и $C_{ib}(U_i, \gamma, t)$ – required and specified optimal values of the useful component; U_i – location coordinates of injection and production wells; q_i – flow rate i - oh well; γ - acid concentration in the injected solution.

To determine the values $C_i(U_i, Q, t)$ and $C_i(U_i, \gamma, t)$ at (1) and (2) It is required to solve the following problems in the context of (x,z) at a given point in time t .

The equation of the mathematical model, reflecting the nature of the change in the filtration flow in the section area $G = \{(x, z, t), a < x < b, c < z < d, 0 < t \leq T\}$ has the following form:

$$\frac{\partial}{\partial x} \left(\frac{kh}{\mu} \left(\frac{\partial P}{\partial x} - \chi_1 \right) \right) + \frac{\partial}{\partial z} \left(\frac{kh}{\mu} \left(\frac{\partial P}{\partial z} - \chi_2 \right) \right) + \sum_{i=1}^M \delta(x - x_i, z - z_i^l) \frac{Q_i(t)}{L} = mh\beta \frac{\partial P}{\partial t}, \quad (3)$$

satisfying the boundary $(\bar{\alpha} \frac{\partial P}{\partial n} + (1 - \bar{\alpha})P) / \Gamma = \varphi(x, z)$ and initial $P(x, z, 0) = P_0(x, z)$ conditions.

After solving equation (3) with initial and boundary conditions and determining the pressure field P , the filtration rate is found according to Darcy's law:

$$v_x = -\frac{k_1}{\mu} \frac{\partial P}{\partial x}, \quad v_z = -\frac{k_2}{\mu} \frac{\partial P}{\partial z}. \quad (4)$$

In order to determine the distribution of the concentration of the useful component in the reservoir, the equation of convective diffusion is considered:

$$\frac{\partial}{\partial x} \left(D \frac{\partial C}{\partial x} \right) + \frac{\partial}{\partial z} \left(D \frac{\partial C}{\partial z} \right) - \frac{\partial(v_x C)}{\partial x} - \frac{\partial(v_z C)}{\partial z} - \frac{\partial N}{\partial t} = m \frac{\partial C}{\partial t} \quad (5)$$

in the region of G with initial $C(x, z, 0) = C_0$ and boundary $(\bar{\alpha} \frac{\partial C}{\partial n} + (1 - \bar{\alpha})C) \Big|_{\Gamma} = \psi(x, z, t)$,

as well as internal $C(x, z, t) \Big|_{(x_i, z_i) = (x_i, z_i')} = C_i$, $\frac{\partial C}{\partial n} \Big|_{(x_i, z_i) = (x_j, z_j')} = 0$ conditions.

The boundary condition is written in a generalized form, which allows us to reflect three possible variants of conditions depending $\bar{\alpha}$: at $\bar{\alpha} = 0$ – conditions of the first kind; at $\bar{\alpha} = 1$ – conditions of the second kind; at $\bar{\alpha} = 0,5$ – conditions of the third kind.

The equation of kinetics of mass transfer, which determines the rate of transition of a substance from one phase to another, as a whole, has the form

$$\frac{\partial N}{\partial t} = \gamma(C) f(C, N, L, \Gamma), \quad N \Big|_{t=0} = N_0. \quad (6)$$

Here h – cut width; k – permeability coefficient; μ – leach viscosity; m – porosity coefficient; P – pressure value, $\chi_{1,2}$ – specific leaching reagent, respectively, in the directions; β – coefficient of elastic capacity; L – number of filter holes in i - well; M – number of injection and production wells; v_x, v_z – components of the filtration rate vector in the directions, respectively; N – the value of the concentration of the useful component in the solid phase; C – reagent concentration value.

The use of the method of variable directions allows us to reduce the solution of the two-dimensional equations of hydrodynamics (3) of the control of the PV process in the conditions of a floor development system to a one-dimensional solution. In this regard, before proceeding with the solution of the two-dimensional hydrodynamic problem, a one-dimensional test problem was formulated and solved with the involvement of analytical functions. As a result of comparing the results of exact and approximate solutions, it was found that the similarity of the solutions did not exceed the accuracy $O(h^2)$. And this served as the basis for the conclusion that the algorithm can be used to solve practical hydrodynamic problems of controlling airflow in heterogeneous environments under the conditions of using a floor development system.

Before applying finite-difference schemes to solve equation (3), it is advisable to introduce dimensionless variables. Dimensionless variables in our case have the form:

$$\bar{x} = \frac{x}{L_x}; \bar{z} = \frac{z}{L_z}; \bar{P} = \frac{P}{P_x}; \bar{k} = \frac{k}{k_x}; \bar{h} = \frac{h}{h_x}; \bar{t} = \frac{t}{t_x}; \bar{\chi} = \frac{\chi}{\chi_x}; \bar{\beta} = \frac{\beta}{\beta_x}; \bar{\mu} = \frac{\mu}{\mu_x}; \bar{q} = \frac{q}{q_x}$$

Where $L_x, L_z, P_x, k_x, h_x, \beta_x, \mu_x, q_x, t_x, \chi_x$ – some characteristic values.

We introduce the following notation:

$$t = \bar{t} \cdot \frac{k_x t_x}{\beta_x \mu_x L_z^2}; \quad q_i(t) = \bar{q}_i(t) \cdot \frac{q_x \mu_x L_z^2}{k_x h_x P_x}; \quad \chi_1 = \bar{\chi} \cdot \frac{L_x \chi_x}{P_x};$$

$$\chi_2 = \bar{\chi} \cdot \frac{L_z \chi_x}{P_x}; \quad z = \bar{z} \cdot \frac{L_z^2}{L_x^2}.$$

We write the equations in a dimensionless form and omit the dashes for the convenience of writing dimensionless problems, so the equations will take the form (3).

To solve equation (3), the variable direction method was applied with access to the following system of equations for internal calculation nodes:

$$mh\beta \frac{P^{n+\frac{1}{2}} - P^n}{0,5\tau} = \Lambda_1 P^{n+\frac{1}{2}} + \Lambda_2 P^n + f^n, \quad (7)$$

$$mh\beta \frac{P^{n+1} - P^{n+\frac{1}{2}}}{0,5\tau} = \Lambda_1 P^{n+\frac{1}{2}} + \Lambda_2 P^{n+1} + f^n, \quad (8)$$

Here:

$$\Lambda_1 P^{n+\frac{1}{2}} = \frac{1}{\Delta x} \left(\frac{k_{i+1,j} h_{i+1,j}}{\mu} \cdot \frac{P_{i+1,j}^{n+\frac{1}{2}} - P_{i,j}^{n+\frac{1}{2}}}{\Delta x} - \frac{k_{i,j} h_{i,j}}{\mu} \cdot \frac{P_{i,j}^{n+\frac{1}{2}} - P_{i-1,j}^{n+\frac{1}{2}}}{\Delta x} \right); \quad (9)$$

$$\Lambda_2 P^{n+1} = \frac{1}{\Delta z} \left(\frac{k_{i,j+1} h_{i,j+1}}{\mu} \cdot \left(\frac{P_{i,j+1}^{n+1} - P_{i,j}^{n+1}}{\Delta z} - \chi \right) - \frac{k_{i,j} h_{i,j}}{\mu} \cdot \left(\frac{P_{i,j}^{n+1} - P_{i,j-1}^{n+1}}{\Delta z} - \chi \right) \right). \quad (10)$$

The computational experiments based on a two-dimensional mathematical model showed that due to the distribution of the initial pressure of the formation, its values at production and injection wells differ (Fig. 1), moreover, the pressure in the zone of the production well is greater than in injection wells.

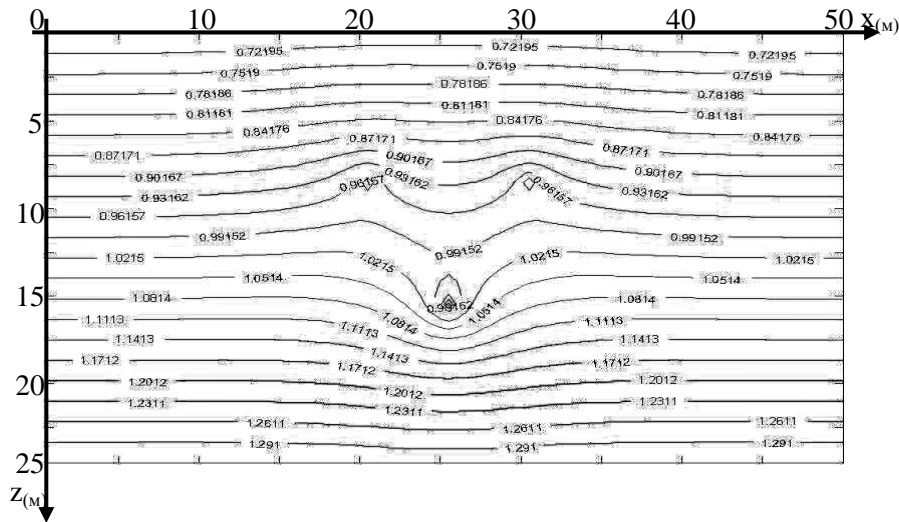

Fig. 1. Isolines of the pressure field on the 30th day of well operation

Over time, the pressure decreases in production wells, and increases in injection wells. therefore, they are gradually balanced and, after that, the pressure in the zone of the production well becomes less than in the zone of the injection well. after a few days, the pressure on the reservoir stabilizes and while maintaining constant flow rates, the reservoir pressure does not change.

The duration of this process depends on the characteristics of the formation, production rates, distances between production and injection wells, properties of the filtration flow, as well as other factors.

The reliability of these conclusions is confirmed by the results obtained using the developed model, algorithm and program. for example, the establishment of pressure in the wells occurs after 30 days, when the distance between the injection and production wells is 15 m (fig. 2a), and after 45 days - 20 m (fig. 2b).

It follows that an increase in the distance between injection and production wells leads to an increase in the time for establishing pressure in the wells. this fact, which follows from the calculation results, is consistent with field observations in the conditions of a floor development system in real conditions.

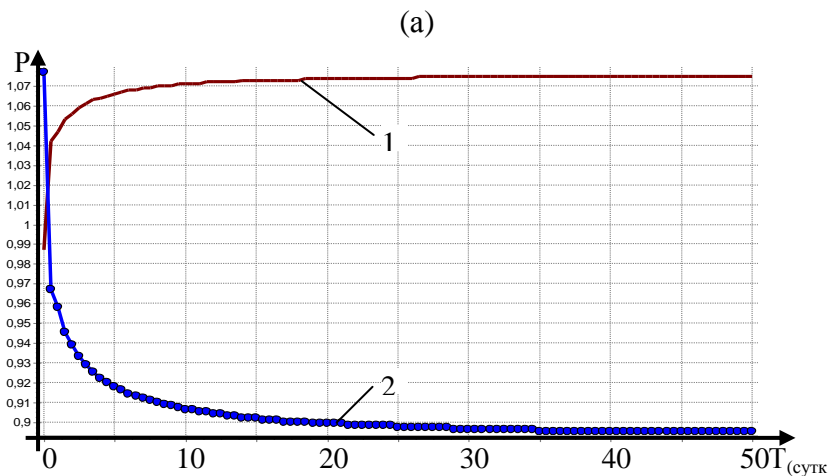

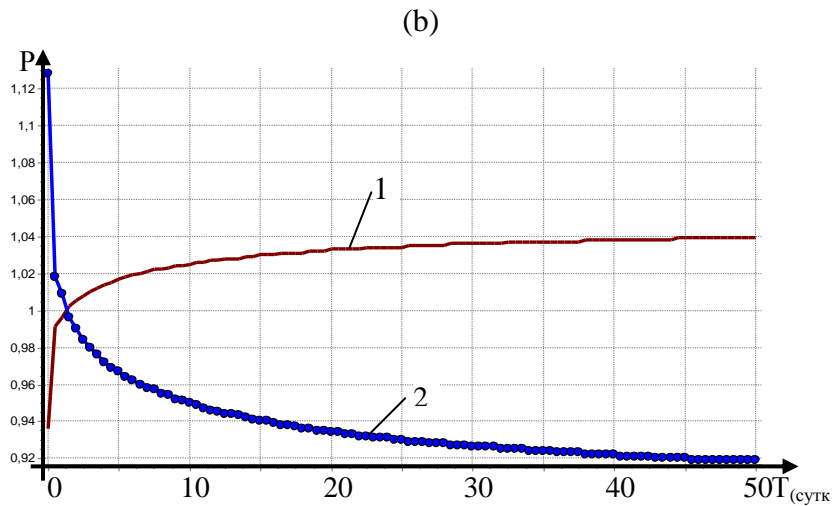

Fig. 2. Dynamics of pressure changes in injection (1) and production (2) wells at different well locations: the distance between the wells is 15 m (a), and - 20 m (b)

In solving problem (5) - (6), the method of variable directions with a monotonic scheme was used to approximate the convective term. At the same time, economical difference schemes for the parabolic type equation with mixed derivatives, first proposed by A.A. Samara.

To determine the concentration field of minerals using the developed algorithm, it is first necessary to distinguish the fields of ore-bearing zones, since in the conditions of a floor system of development, filtration and ore-bearing zones have different boundaries.

In fig. Figure 3 shows the ore layer developed by the PV method in the conditions of a floor development system; two injection and one production wells are installed.

As you can see fig. 3, the thickness of the horizon differs from the thickness of the ore-bearing zone, and their boundaries are different. Filters for injection wells are located above the ore-bearing zone, and the filter of the production well is located below the ore-bearing zone. The injected solution, moving along the ore-bearing zone, captures minerals and moves towards the production well.

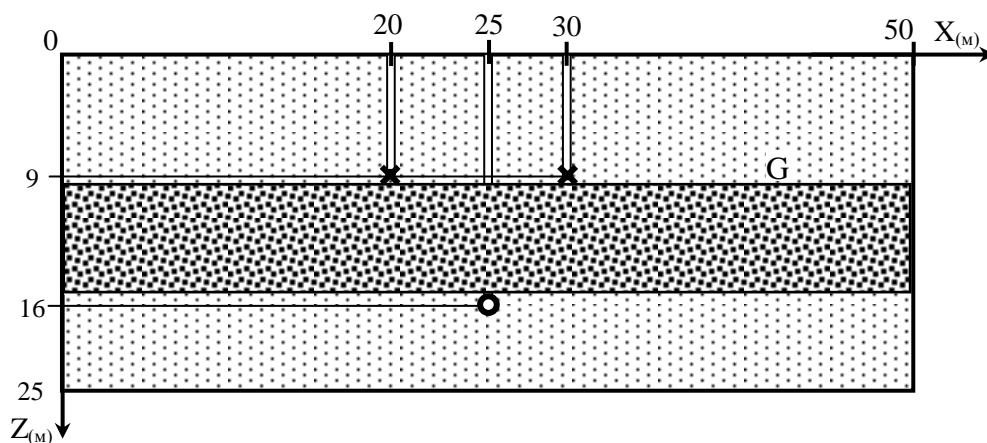

Fig. 3. The layout of the ore layer

- non-ore filtration zone, - ore layer

Using the developed algorithm, results were obtained at various points in time based on test data corresponding to a real object.

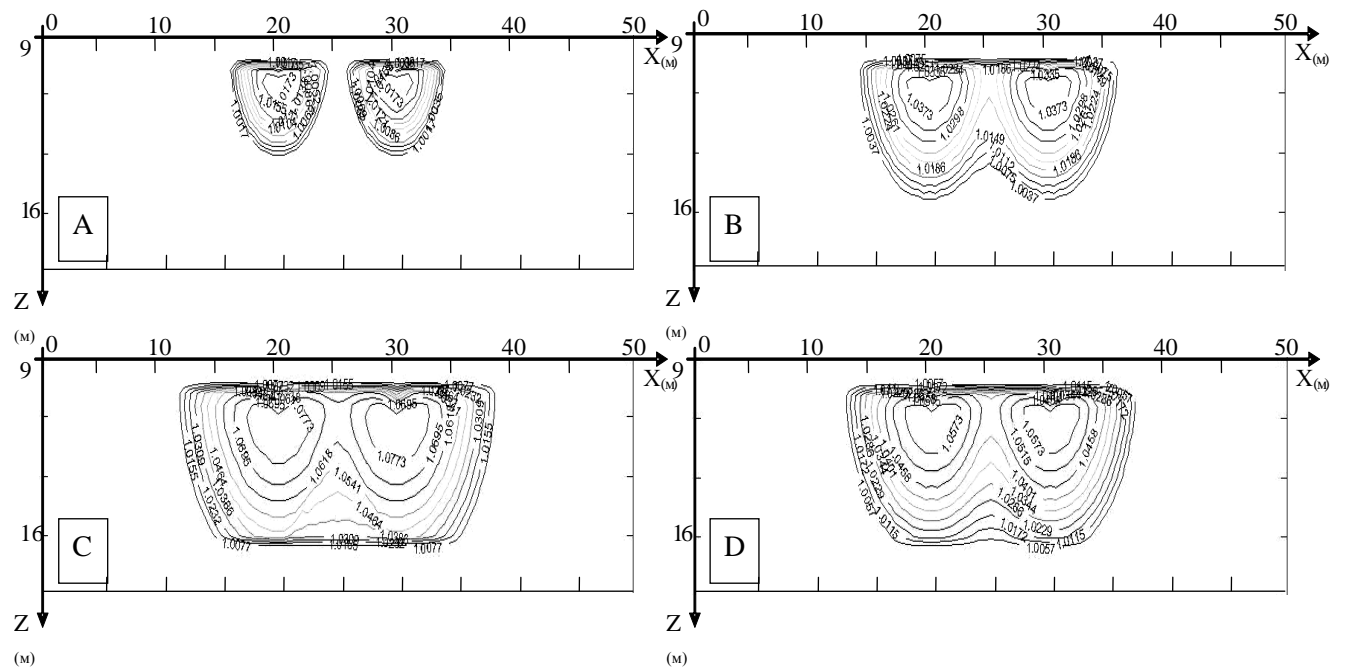

Fig. 4. The dynamics of the concentration value over time:
 A - 10 days; B - 20 days; C - 30 days; D - 40 days.

In fig. Figure 4 shows contours of the concentration of the reagent in the ore-bearing zone. It can be seen from it that over time, the concentration of the reagent increases in the developed formation. These and other facts, which more adequately describe the physical phenomena of the PV process, allow us to recommend the developed model and computational algorithm for studying the hydrodynamics and diffusion process when developing a PI field by the PV method in a floor development system, as well as to use it in tasks of controlling the PV process in real conditions .

In fig. 5 shows a geological diagram of section II-II of operational block 1-80-1. One production and two injection wells operate in the section.

The length of the filters for injection and production wells is about 6.2 m, areal productivity is on average 3.5 kg / m³, ore capacity is on average 6.4 m.

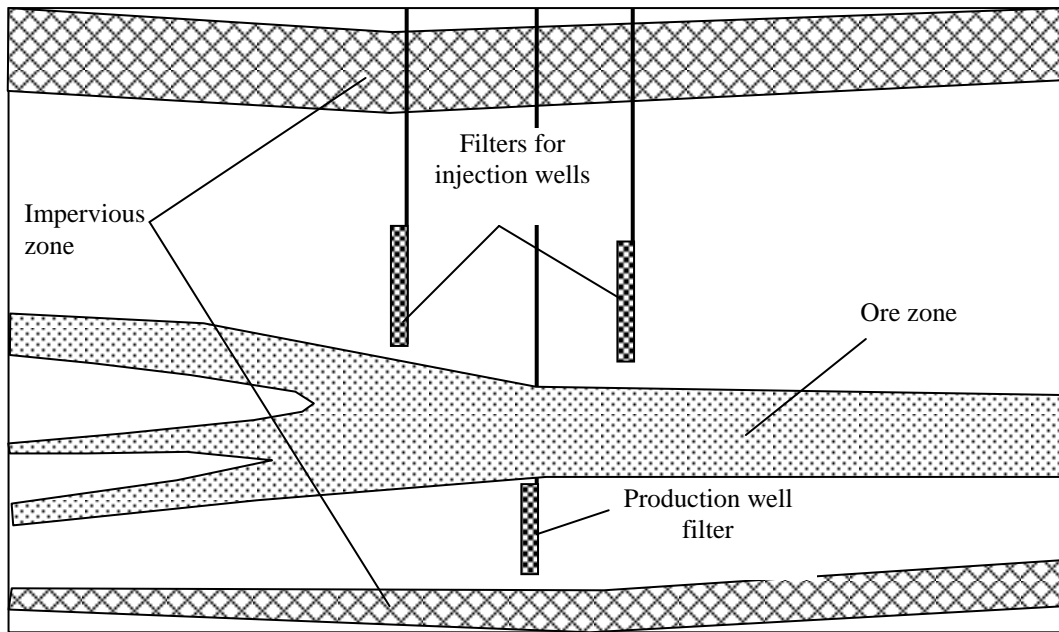

Fig. 6. Section II-II of operational unit 1-80-1

Among other positive hydrogeological indices for PV, the horizon has high permeability (medium $n_{cp}=5,8$ м/сyт) and low mineralized (1.7-2.0 g / l) water of sulfate-chloride-sodium-calcium composition with a uranium content of $2\cdot 6\cdot 10^{-5}$ г / l and temperature 19-21°C, and the sands themselves are anisotropic in terms of filtration, i.e. less permeable cross layering than layering ($K_a=1:5$). The active (open) porosity of the sand varies slightly, amounting to 0.30-0.35.

Sectional Initial Pressure Distribution II-II presented in fig. 7.

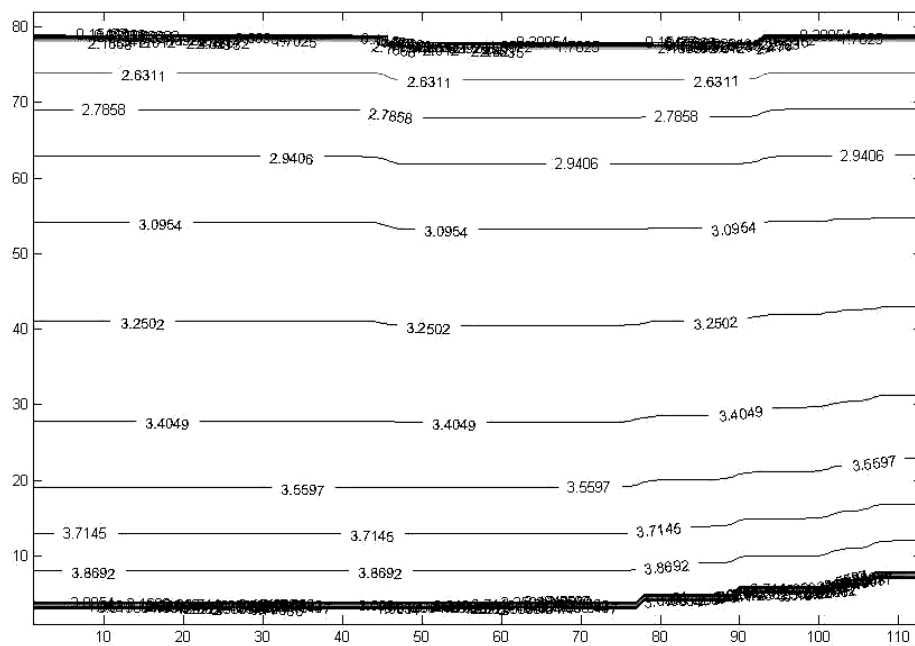

Fig. 7. The state of the initial pressure in the context of II-II operational unit 1-80-1

The results of the actual and calculated concentration values are compared in Fig. 8.

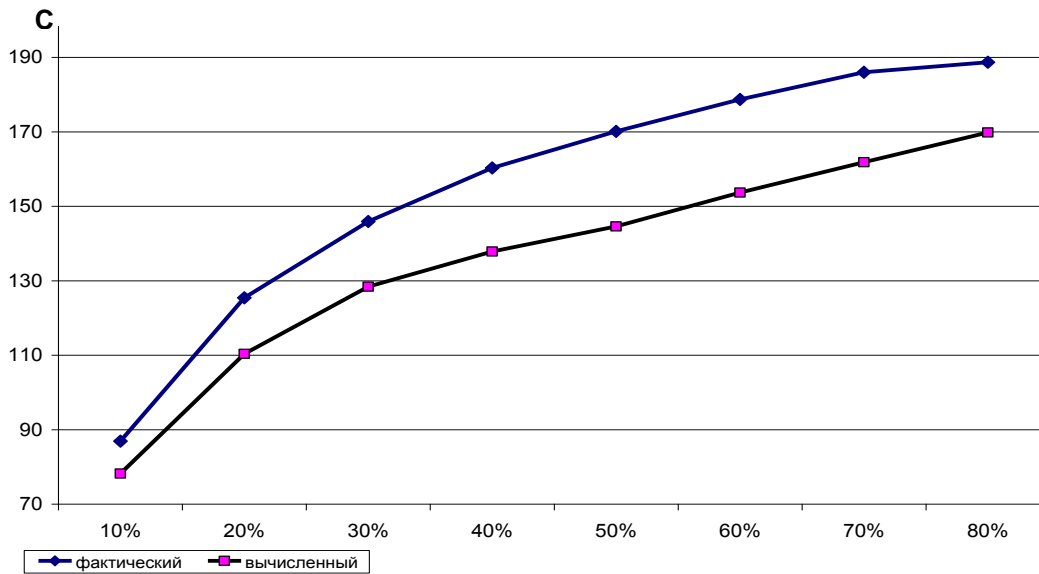

Fig. 8. graph comparing actual and calculated concentration values

Comparisons of actual and calculated results showed that, based on the developed computerized control model, it is possible to predict the further state of the formation in the PW process, which makes it possible to control the process based on predicted results. Typically, in control systems, the influence of the control action is not immediately apparent. It should be evaluated some time after exposure. And it will be present in it feedback and the correction process. This can be depicted using the main components of management processes (Fig. 9).

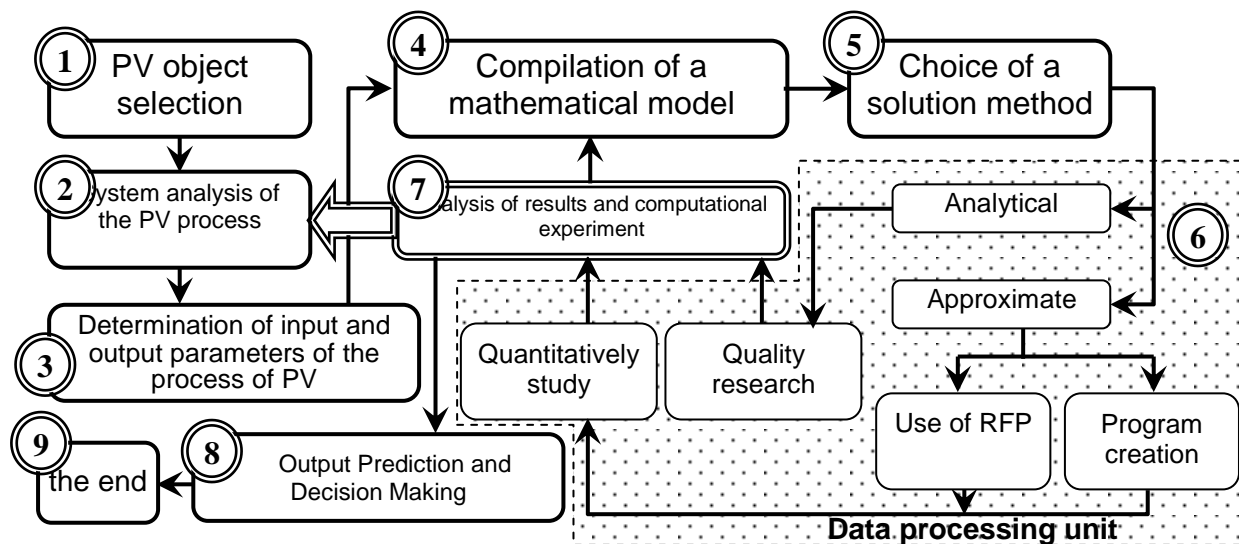

Fig. 9. The general scheme of the computer model of the process control PV in the conditions of application of a floor system.

Here, as the initial data, information is used on various input parameters of the mathematical model of the process control of the industrial process based on the decision made. By solving the above models, we study the effect of parameters on the physical process and in the end

result we get a certain database of decision-making to achieve the goal. The software we created allows us to expand and replenish the database. We give an example that confirms this proposition.

Suppose that you want to control the PV process under the conditions of using a floor development system (select the value of the acid concentration in the leaching reagent and the flow rates of injection and production wells) so that after 270 days the average concentration of the useful component in the production well reaches a predetermined concentration value, i.e. $C_{cp}=155,2$ mg / l.

To solve this control problem using the above computational algorithm, it is necessary to refine the input parameters. In our case, we need to determine the values γ ($\gamma \in [a;b]$) and Q ($Q \in [c;d]$), Where $a=0,05 \cdot 10^{-3}$, $b=0,5 \cdot 10^{-3}$ (in the form of dimensionless quantities), $c=4,4$ $m^3/ч$, $d=5,4$ $m^3/ч$.

If we take $n = 7$, then we have to select the values γ and Q of the following values:

$\gamma_1=0,05 \cdot 10^{-3}$, $\gamma_2=0,125 \cdot 10^{-3}$, $\gamma_3=0,2 \cdot 10^{-3}$, $\gamma_4=0,275 \cdot 10^{-3}$, $\gamma_5=0,35 \cdot 10^{-3}$, $\gamma_6=0,425 \cdot 10^{-3}$, $\gamma_7=0,5 \cdot 10^{-3}$;
 $q_1=4,4$; $q_2=4,57$; $q_3=4,73$; $q_4=4,9$; $q_5=5,07$; $q_6=5,24$; $q_7=5,4$; $\varepsilon=0,0001$.

Based on these values, the concentration value in the production well is determined by solving problem (1) - (6) in section II-II of production block 1-80-1.

The calculation results are shown in table 1.

Table 1 The results of solving the control problem

Q ($m^3/ч$)	γ_i (x 10^{-3}) kg / l						
	0,05	0,128	0,2	0,275	0,35	0,425	0,5
4,4	120,6	129,8	135,1	139,4	141,7	152,5	168,5
4,57	122,4	132,2	136,2	144,7	145,0	154,4	173,2
4,73	124,3	136,1	139,7	147,9	149,9	160,6	175,0
4,9	127,6	139,0	144,3	152,2	154,4	164,4	179,3
5,07	128,5	142,8	146,5	155,6	156,2	169,2	183,8
5,24	131,8	144,6	148,4	157,6	160,8	173,3	186,4
5,4	136,1	148,7	150,8	160,7	164,7	175,6	188,7

An analysis of the results shows that the closest to the required $C_{cp}=155,2$ мг/л значения концентрации получены при следующих значениях управляющих факторов γ и q : $\gamma=0,275 \cdot 10^{-3}$; $q=5,07$ $m^3/ч$.

Thus, it can be argued that with the help of the developed computer model, it is possible to predict and control the PV process in the conditions of a floor development system, make technological decisions based on multivariate computational results.

4. CONCLUSION/RECOMMENDATIONS

The main result of the thesis is the solution of the scientific and technical problem of creating a computer model for controlling the PV process in heterogeneous environments in the conditions of a floor development system to support the adoption of technological decisions.

The following scientific and practical results were obtained:

Based on the analysis of the current state of control of PV processes in heterogeneous environments, the need to take into account the features of the applied development system is substantiated.

A mathematical description of the optimization problem of the functional is given and the well production rate and reagent concentration value are selected, the task of controlling the PV process in terms of using a floor development system is formulated. A general view of the mathematical model is given under various initial, boundary, as well as internal conditions.

An effective computational algorithm has been developed for solving one- and two-dimensional hydrodynamic problems of controlling PV processes in the conditions of using a floor development system taking into account the specific gravity of the reagent. And also conducted computational experiments to verify the reliability of the developed computational algorithms.

An effective computational algorithm has been developed to solve the two-dimensional diffusion problem of controlling the PV process under the conditions of implementing a floor development system taking into account the dissolution kinetics.

The degree of adequacy of the developed mathematical models for controlling the PV process is determined, and recommendations are formed for their use at specific objects.

Models for controlling the PV process are adapted to a specific PV object, which is being developed under the conditions of a floor development system, forecasts are made and an example of technological decision making is presented.

To support the adoption of technological decisions, an algorithm and a software product module for three-dimensional visualization of two-dimensionally specified surfaces of the PV process indicators have been developed.

Based on the computer model of the control process of the PV process under the conditions of using a floor development system, the forecasting of changes in the main parameters of the development of the operational unit 1-80-1 of the North Bukinay field was carried out.

5. REFERENCES

- [1] Alimov I., Zhuraev T.M., Ergashev B.B. Information aspects of modeling the process of filtering liquids and gases // Modern problems and prospects of mechanics: Materials of a scientific and technical conference. - Tashkent, 2006.-- S. 79.
- [2] Pirnazarova T.E., Zhuraev T.M. Mathematical models for the development of oil and gas condensate fields // Problems of the development of oil and gas condensate fields and their solutions: Materials of the Republican Scientific and Practical Conference. - Tashkent, 2006. –S. 24-27.
- [3] Alimov I., Zhuraev T.M. Taking into account the main properties of the process of underground leaching in modeling // Geotechnology: innovative methods of subsoil use in the XXI century: Materials of the international scientific and technical conference. - Moscow-Navoi, 2007. –S. 76-77.
- [4] Alimov I., Zhuraev T.M. Oil of konlarid solistirma kirchin kisinba olgan kolda oil filtration with models and algorithms // Uzbek journal “Problems of mechanics” - Tashkent, 2007. - No. 4. - P.53-56.

- [5] Zhuraev T.M. Solution of two-dimensional problems of underground leaching by the Bubnov-Galerkin method // Bulletin of Tashkent State Technical University. - Tashkent, 2007. - No. 3. –C. 3-10.
- [6] Alimov I., Zhuraev T.M., Ismanova K.D. Evaluation of geotechnological parameters affecting changes in the dynamics of concentration // Current status and ways of development of information technology: Materials of the Republican scientific and technical conference. - Tashkent, 2008.-- S. 194-197.
- [7] Alimov I., Zhuraev T.M. Clarification of the parameters of the process of underground leaching // Current status and ways of development of information technology: Materials of the Republican scientific and technical conference. - Tashkent, 2008.-- S. 199-202.
- [8] Alimov I., Zhuraev T.M. The choice of a computational experiment to approximate the heterogeneity function in fluid filtration problems // Proceedings of the international conference on the propagation of elastic and elastoplastic waves, dedicated to the 100th birthday of academician Hero of Socialist Labor H.A. Rakhmatulin. - Bishkek, 2009.-- S. 111-113.
- [9] Alimov I., Zhuraev T.M. Improving the algorithm for solving the problem of the process of underground leaching for accurate decision making // Modeling and control in the real sector of the economy: Materials of the Republican scientific and technical conference. - Tashkent, 2009.-- S. 123-125.
- [10] Zhuraev T.M., Ismanova K.D. Solving the problems of the process of underground leaching subject to floor development systems // Modern equipment and technologies of the mining and metallurgical industry and their development: Materials of the international scientific and technical conference. - Navoi, 2010.-- S. 94-96.
- [11] Pirnazarova T.E., Zhuraev T.M., Atakhanov M.Kh. The program for calculating the development parameters of floor-by-stage ore deposits using geotechnological methods // State Patent Office of the Republic of Uzbekistan. Certificate No. DGU 02026. 08/09/2010
- [12] Zhuraev T.M. Model and computational algorithm for solving problems of the geotechnological process in piecewise heterogeneous formations // Uzbek journal "Problems of Informatics and Energy". - Tashkent, 2010. - No. 5. - S. 18-23.
- [13] Alimov I., Zhuraev T.M. Physical and chemical technology of the process of underground leaching // Proceedings of the international conference "Rakhmatulin readings." - Bishkek, 2011.-- S. 134-136.
- [14] Zhuraev T.M. Models and algorithms for controlling the PV process in the condition of a floor development system // Current status and prospects for the development of information technology: Materials of the Republican scientific and technical conference. - Tashkent, 2011.-- S. 81-86.
- [15] Zhuraev T.M., Atakhanov M.Kh. Software development for visualization of two-dimensional numerical results in three-dimensional graphical form // Current status and prospects for the development of information technology: Materials of the Republican scientific and technical conference. - Tashkent, 2011. Volume 1, -